



ПРОФЕССИОНАЛЬНЫЕ
АВТОКОМПОНЕНТЫ



100% контроль качества

Марка TRIALLI славится ответственным подходом к качеству, но мы не стоим на месте. Мы создали многоуровневую систему контроля качества, которая исключает брак полностью.



Каталог крестовин TRIALLI 01 (01) 2018



2

CROCIERA CARDANICA крестовина - u-joint



Крестовина кардана — это шарнир неравных угловых скоростей. Карданная передача с шарниром неравных угловых скоростей применяется на заднеприводных автомобилях и автомобилях с полным приводом для передачи крутящего момента от силового агрегата на колеса автомобиля и позволяет изменять угол вращения под небольшими углами (в пределах пяти градусов). Особенностью шарнира неравных угловых скоростей является неравномерная (циклическая) передача крутящего момента, т.е. за один оборот ведомый вал дважды отстает и дважды обгоняет ведущий вал. Для компенсации неравномерности вращения в карданной передаче применяется не менее двух шарниров, по одному с каждой стороны карданного вала. При этом вилки противоположных шарниров располагаются в одной плоскости.

Внимание! При замене крестовины карданного вала необходимо осмотреть состояние резиновой муфты (не допустимы трещины или механические повреждения, отслоение резины от стальных вкладышей), промежуточной опоры (не допустимы трещины, разрыв эластичной обоймы, подшипник промежуточной опоры должен плавно вращаться). При необходимости заменить дефектные детали!

Внимание! В крестовинах Trialli поступающих в продажу с производства заложена транспортировочная смазка, при установке необходимо заменить смазку!

В крестовинах карданных валов допускается использование пластичной смазки на литиевой основе с допуском NLGI 2 или NLGI LB (для тяжелых условий).



Марка	Модель	Характеристики	Номер в каталоге автопроизводителя		Артикул Trialli
NISSAN	Almera N16 (00-)	D 15 mm H 40 mm	NISSAN:	48810-BN008	CC 901 
BMW	3 E36 (90-) 5 E34 (88-)		BMW:	32 31 1 092 958 32 31 1 150 489	
MITSUBISHI	Pajero II (90-) Pajero III (00-)				
MERCEDES-BENZ	Vito (W638) (96-)				
LADA	2106 2105 2107	D 16 mm H 39 mm	LADA:	2105-3401104	CC 905 
UAZ	3151		UAZ:	469-3401153	
OPEL	Vectra C (02-)				







4

CROCIERA CARDANICA
крестовина - u-joint

Марка	Модель	Характеристики	Номер в каталоге автопроизводителя	Артикул Trialli
TOYOTA	RAV 4 (96-) Camry/Vista (90-) Carina ED (89-) Celica (90-) Corolla (82-) Crown (99-08) Estima (93-) Mark2 (96-)	D 15.07 mm H 39 mm	TOYOTA: 54209-32010	CC 912 
NISSAN	X-Trail T30 (01-)			
LAND ROVER	Discovery III (04-)			
TOYOTA	Camry (96-)	D 16 mm H 40 mm	TOYOTA: 45210-32151	CC 910 
LEXUS	RX I (97-)			



Марка	Модель	Характеристики	Номер в каталоге автопроизводителя		Артикул Trialli
GAZ	3302 2217 2705 3310 3309 3308 3306 4301	D 19 mm H 44.6 mm	GAZ:	3110-3401481	CC 902 
					
KAMAZ	4308 4310 4326 4350 5320 5350 5410 5511 6350 6520 6522 6540 5321 5411 6511	D 28 mm H ₁ 37 mm H 67.8 mm	KAMAZ:	5320-3422039	CC 906 
 					



6

CROCIERA CARDANICA
крестовина - u-joint

Марка	Модель	Характеристики	Номер в каталоге автопроизводителя	Артикул Trialli	
URAL	5557	D 28 mm H ₁ 42.5 mm H 73 mm	URAL:	400-2201025	CC 907
	5323				
	6370				
	3555				
	4420				
MAZ	504		MAZ:	408-2201025	
	509				
	516				
	53055				
	5309				
	5316				
	5337				
	5340				
5440					
MAZ	105	D 19 mm H 56.3 mm	MAZ:	104-3444026 6430-3444063	CC 908
	103				
	104				
	107				
	152				
					

CROCIERA CARDANICA
крестовина - u-joint

7



Марка	Модель	Характеристики	Номер в каталоге автопроизводителя		Артикул Trialli
-------	--------	----------------	------------------------------------	--	-----------------

VOLVO TRUCKS

FH 12 (93-)
FH 16 (93-)

D 19.08 mm
H 48 mm

VOLVO:

7035955231

CC 914



TOYOTA:

37420-60040
37602-60200

LADA

2101-2107

D 23.84 mm
H 61.24 mm

LADA:

21010-2202025-00

CC 506





8

CROCIERA CARDANICA
крестовина - u-joint

Марка	Модель	Характеристики	Номер в каталоге автопроизводителя	Артикул Trialli
-------	--------	----------------	------------------------------------	-----------------

LADA

2101-2107

D 23.84 mm
H 61.24 mm

LADA:

21050-2202025-00

CC 146

LADA

2121
2123
2131
2120D 28 mm
H 71 mm

LADA:

21210-2202025-00

CC 394



Марка	Модель	Характеристики	Номер в каталоге автопроизводителя		Артикул Trialli
LADA	2121 2123	D 27 mm H 74.61 mm	LADA:	21230-2202025-00	CC 395
FORD	Transit VI (00-)		FORD:	1 798 134	
LAND ROVER	Defender (83-)				
NISSAN	Pathfinder R51 (05-) Navara (05-)		NISSAN:	37125-2X801	
IZH	2140 412 2715	D 28 mm H ₁ 52.2 mm H 83 mm	IZH:	412-2201025	CC 512
GREAT WALL	Deer (05-) Safe (04-)		GREAT WALL:	2203103-D07	



10

CROCIERA CARDANICA
крестовина - u-joint

Марка	Модель	Характеристики	Номер в каталоге автопроизводителя	Артикул Trialli
GAZ	2217 3110 3302 24 3111	D 30 mm H ₁ 55 mm H 88 mm	GAZ: 3102-2201026 3102-2205025	CC 561
UAZ	2206 Hunter (03-) 469 Patriot (97-)		UAZ: 469-2201025	
MTZ	82			

GAZ	A21R23 A21R22 Gazelle-Business Gazelle-Next (13-)	D 29.98 mm H 92.1 mm	GAZ: A21R23.2200010 A21R33.2200010	CC 562
-----	--	-------------------------	---	-------------------





Марка	Модель	Характеристики	Номер в каталоге автопроизводителя		Артикул Trialli
SUZUKI	Jimny II (98-) Jimny III (03-) Grand Vitara (98-) Vitara (96-) Samurai (98-)	D 25 mm H 63.8 mm	SUZUKI:	27200-83812	CC 401 
MITSUBISHI	Outlander I (03-) L200 (96-) Pajero II (90-) Pajero III (00-)		MITSUBISHI:	MR196837	
NISSAN	Terrano (93-)				
MITSUBISHI	Pajero II (90-) Pajero Sport (08-) L200 (96-) Pajero III (00-)	D 30 mm H ₁ 55 mm H 84.8 mm	MITSUBISHI:	MR232151	CC 402 
		 			



12

CROCIERA CARDANICA
крестовина - u-joint

Марка	Модель	Характеристики	Номер в каталоге автопроизводителя	Артикул Trialli
-------	--------	----------------	------------------------------------	-----------------

MITSUBISHIL200 (96-)
Pajero II (90-)
L200 (06-)
Pajero Sport (08-)
Pajero III (00-)
Pajero IV (06-)D 25 mm
H 76.8 mm**MITSUBISHI:**

MR196838

CC 403**MITSUBISHI**L200 (96-)
L200 (06-)
Pajero II (90-)
Pajero Sport (08-)D 30 mm
H₁ 71 mm
H 101 mm**MITSUBISHI:**

MR377128

CC 404



Марка	Модель	Характеристики	Номер в каталоге автопроизводителя	Артикул Trialli
-------	--------	----------------	------------------------------------	-----------------

HONDA

HR-V I (98-)
CR-V I (95-)

D 20.06 mm
H 52.8 mm

HONDA:

40100-S10-A01

CC 410



NISSAN

Pathfinder WD21 (85-)
NP300 (08-)

D 27 mm
H₁ 46 mm
H 72 mm

NISSAN:

37125-01G25

CC 420





14

CROCIERA CARDANICA
крестовина - u-joint

Марка	Модель	Характеристики	Номер в каталоге автопроизводителя	Артикул Trialli
-------	--------	----------------	------------------------------------	-----------------

NISSANNP300 (08-)
Patrol Y61 (97-)D 28 mm
H₁ 53.1 mm
H 79.5 mm**NISSAN:**

37125-VB925

CC 421**NISSAN**Patrol Y60 (87-)
Patrol Y61 (97-)D 32 mm
H₁ 65.1 mm
H 99.9 mm**NISSAN:**

37125-01J25

CC 426



Марка	Модель	Характеристики	Номер в каталоге автопроизводителя	Артикул Trialli
KIA	Sorento (02-) Sorento (06-)	D 27 mm H ₁ 46 mm H 72 mm	HYUNDAI: 49598-3E100	CC 440 
 				
CHEVROLET	Captiva (06-)	D 24.06 mm H 74.4 mm	GM: 20781756	CC 441 
OPEL HYUNDAI MERCEDES-BENZ DAEWOO	Antara (06-) Santa Fe II (06-) Vito (W639) (03-) Winstorm (07-)		OPEL: 04 46 073	
 				



16

CROCIERA CARDANICA
крестовина - u-joint

Марка	Модель	Характеристики	Номер в каталоге автопроизводителя	Артикул Trialli
-------	--------	----------------	------------------------------------	-----------------

BMW

5 E34 (88-)

D 24.06 mm
H 62 mm**BMW:**

26 11 7 518 304

CC 470**NISSAN**X-Trail T31 (07-)
Qashqai J10 (06-)**NISSAN:**

37126-11975

**JEEP**Cherokee XJ (84-)
Wrangler TJ (96-)
Grand Cherokee (92-)
Wrangler YJ (86-)D 27 mm
H₁ 52.6 mm
H 81.75 mm**CHRYSLER:**

J812 6637

CC 490



Марка	Модель	Характеристики	Номер в каталоге автопроизводителя		Артикул Trialli
-------	--------	----------------	------------------------------------	--	-----------------

CHEVROLET

TrailBlazer (01-)
Tahoe II (99-)

D 28.57 mm
H₁ 61.9 mm
H 92.5 mm

GM:

89029290

CC 491



CHERY

Tiggo (T11) (06-)

D 29 mm
H 77 mm

CHERY:

T11-2202020CB

CC 508



GREAT WALL

Hover H5 (11-)



GREAT WALL:

2201116-D01



18

CROCIERA CARDANICA
крестовина - u-joint

Марка	Модель	Характеристики	Номер в каталоге автопроизводителя		Артикул Trialli
-------	--------	----------------	------------------------------------	--	-----------------

FORD

Transit VII (06-)

D 30.18 mm
H 92 mm**FORD:**

1835511

CC 515**FORD**

Transit VI (00-)

D 30 mm
H 81.7 mm**FORD:**

1C15 4635 CA

CC 516**NISSAN**

Cabstar (07-)

**NISSAN:**

37125-MB925





Марка	Модель	Характеристики	Номер в каталоге автопроизводителя		Артикул Trialli
HYUNDAI	Santa Fe (00-) Starex (H-1) (96-) Porter (H-100/TagAZ) (96-) Porter IV (H-100) (04-)	D 27 mm H 80 mm	HYUNDAI:	49140-4A000	CC 524



KIA	Sportage II (04-) Sportage I (93-) Sorento (02-)	D 26.5 mm H ₁ 48 mm H 71 mm	KIA:	0N010-25-060A	CC 526
-----	--	--	------	---------------	-------------------







HYUNDAI	Tucson I (04-)		FORD:	3 636 482	
FORD	Ranger (06-)				











20

CROCIERA CARDANICA
крестовина - u-joint

Марка	Модель	Характеристики	Номер в каталоге автопроизводителя	Артикул Trialli
KIA	Sportage III (10-) Sorento II (09-)	D 24.06 mm H 64 mm	HYUNDAI: 49300-2S000	CC 529 
HYUNDAI	iX35 (10-) Tucson II (11-)			
HONDA	Pilot (08-)			
MAZDA	CX-9 I (07-)			
RENAULT	Duster (10-)	D 19.05 mm H 55.5 mm	RENAULT: 320003602R	CC 538 
NISSAN	Terrano (14-)			



Марка	Модель	Характеристики	Номер в каталоге автопроизводителя		Артикул Trialli
KIA	Sorento (02-)	D 32 mm H ₁ 57 mm H 92 mm	KIA:	49598-3E300	CC 542 
 					
SSANGYONG	Kyron (05-) Actyon (05-) Korando (95-) Actyon Sport (05-) Musso (93-) Rexton (02-)	D 27 mm H 82 mm	SSANGYONG:	3311501000	CC 549 
GREAT WALL	Hover H5 (11-)	 	GREAT WALL:	2201116-F00	
NISSAN	Pathfinder R51 (05-) Navara (05-)		NISSAN:	37125-EB30A	
MAZDA	BT-50 I (06-)				
JEEP	Wrangler JK (07-)				



22

CROCIERA CARDANICA
крестовина - u-joint

Марка	Модель	Характеристики	Номер в каталоге автопроизводителя	Артикул Trialli
-------	--------	----------------	------------------------------------	-----------------

TOYOTA

RAV 4 (00-)

D 22.06 mm
H 57.5 mm

TOYOTA:

04371-13020

CC 550



SUBARU

Forester SF (97-)



LEXUS

RX II (03-)



TOYOTA

Land Cruiser Prado 120 (02-)
Land Cruiser Prado 150 (09-)
FJ Cruiser (07-)
Land Cruiser 100 (98-)
Land Cruiser 200 (07-)
Tundra (00-)D 29.01 mm
H₁ 47.3 mm
H 77.2 mm

TOYOTA:

04371-60070

CC 551





Марка	Модель	Характеристики	Номер в каталоге автопроизводителя	Артикул Trialli
-------	--------	----------------	------------------------------------	-----------------

TOYOTA

Land Cruiser 200 (07-)
Land Cruiser 100 (98-)
Land Cruiser 80 (89-)

D 32.01 mm
H₁ 60 mm
H 92 mm

TOYOTA:

04371-36050

CC 552



TOYOTA

Hilux (05-)

D 27 mm
H 92.1 mm

TOYOTA:

04371-0K080

CC 553



NISSAN

Pathfinder R51 (05-)
Navara (05-)

MAZDA

BT-50 I (06-)

JEEP

Grand Cherokee (99-)

MERCEDES-BENZ

Sprinter (95-)





24

CROCIERA CARDANICA
крестовина - u-joint

Марка	Модель	Характеристики	Номер в каталоге автопроизводителя		Артикул Trialli
-------	--------	----------------	------------------------------------	--	-----------------

IVECO

Daily III (99-)
Daily V (11-)D 30.24 mm
H 106.3 mm

IVECO:

93158199

CC 723

MERCEDES-BENZ

Vito (W638) (96-)
Sprinter (06-)D 24.09 mm
H 88.1 mm

MERCEDES-BENZ: A9064100616

CC 747



Марка	Модель	Характеристики	Номер в каталоге автопроизводителя	Артикул Trialli
-------	--------	----------------	------------------------------------	-----------------

MERCEDES-BENZ Vito (W638) (96-)
Sprinter (06-)

D 31.08 mm
H 88.5 mm

MERCEDES-BENZ: A4604101904

CC 748



MERCEDES-BENZ Vito (W638) (96-)
Sprinter (06-)

D 27.08 mm
H 88 mm

MERCEDES-BENZ: A9064103401

CC 749



KIA

Sorento (06-)





26

CROCIERA CARDANICA
крестовина - u-joint

Марка	Модель	Характеристики	Номер в каталоге автопроизводителя	Артикул Trialli
-------	--------	----------------	------------------------------------	-----------------

ISUZU

ELF 7.5 (03-) (NLR75)
ELF 9.5 (03-) (NQR90)D 35 mm
H 103.9 mm

ISUZU:

1-37300-058-0
1-37300-089-0**CC 760**

ISUZU

ELF 3.5 (03-) (NLR85)

D 33 mm
H 93 mm

ISUZU:

8-97080505-0
8-98033605-0**CC 761**



Марка	Модель	Характеристики	Номер в каталоге автопроизводителя		Артикул Trialli
-------	--------	----------------	------------------------------------	--	-----------------

MITSUBISHI
FUSO

Canter TD (02-)
Canter TD (10-)

D 31.75 mm
H 102 mm

MITSUBISHI:

MK996631

CC 770



HYUNDAI

HD120 (04-)

D 46 mm
H 142 mm

HYUNDAI:

49140-73000

CC 771





28

CROCIERA CARDANICA
крестовина - u-joint

Марка	Модель	Характеристики	Номер в каталоге автопроизводителя	Артикул Trialli
-------	--------	----------------	------------------------------------	-----------------

HYUNDAI

HD 45/65/72/78 (04-)

D 34.92 mm
H₁ 72 mm
H 106.5 mm

HYUNDAI:

49150-45220

CC 772



GAZ

53
66
3307
3308D 35 mm
H 98 mm

GAZ:

53A-2201025
33081-2202010

CC 653



PAZ

3205

URAL

4320
4420



Марка	Модель	Характеристики	Номер в каталоге автопроизводителя		Артикул Trialli
-------	--------	----------------	------------------------------------	--	-----------------

GAZ	GAZon-Next (14-)	D 34.95 mm H 106.3 mm	GAZ:	4530307 C41R13-4530307	CC 655
-----	------------------	--------------------------	------	---------------------------	--------



MAZ	5336 5432 5516 6303 6422	D 62 mm H 173 mm	MAZ:	540-2201025	CC 612
-----	--------------------------------------	---------------------	------	-------------	--------



BELAZ	7522 7540
-------	--------------





30

CROCIERA CARDANICA
крестовина - u-joint

Марка	Модель	Характеристики	Номер в каталоге автопроизводителя	Артикул Trialli
KAMAZ	4326 5315	D 50 mm H 155 mm	KAMAZ: 4310-2205025	CC 613 
MAZ	103 104 105 107 152 5337 54323 5516 5551 6422			
KRAZ	250			
KAMAZ	4308 4311 4326 5320 5321 53212 5410 54112 5511 55102 55112 55115	D 50 mm H 135 mm	KAMAZ: 5320-2205025 5320-2205026 6520-2201025	CC 614 
ZIL	131 133			
URAL	4320 5557			



Марка	Модель	Характеристики	Номер в каталоге автопроизводителя	Артикул Trialli
-------	--------	----------------	------------------------------------	-----------------

KAMAZ

65115

D 50 mm
H 155 mm

KAMAZ:

53205-2205025

CC 617



MAZ

5336
5432
6303
6422



KAMAZ

6522

D 52 mm
H 154 mm

KAMAZ:

340-002-7205
41-015-7205

CC 619





**CROCIERA CARDANICA**
крестовина - u-joint

Марка	Модель	Характеристики	Номер в каталоге автопроизводителя		Артикул Trialli
KAMAZ	4308	D 39 mm H 118 mm	KAMAZ:	5320-2201025	CC 620 
	4311				
	4326				
	5320				
	5321				
	53212				
	5410				
	54112				
	55102				
	5511				
	55112				
55115					
PAZ	3204		ZIL:	130-2201025	
URAL	4320				
	4420				
	5323				
	5557				
ZIL	130				
	133				
	4331				
	4333				
	4421				
4945					
BELAZ	7512				
	7549				





Марка	Модель	Характеристики	Номер в каталоге автопроизводителя		Артикул Trialli
KAMAZ	5320	D 39 mm H 118 mm	KAMAZ:	5320-2201025-01 5320-2201025-10	CC 621
URAL	4320 5557	 	GAZ:	4301-2201025-A	
GAZ	33104 33106 4301		FOTON:	HWJ3-382-00	
FOTON	Aumark BJ10 (05-)				
MAN	F / M / L 2000 F / M / G 90 F 7/8/9	D 52 mm H 147.2 mm	MAN:	81.39126.6020 81.39126.6030	CC 702
MAN BUS/ NEOPLAN	RH Lion's Coach/Regio/Star Cityliner Jetliner Tourliner Trendliner	 			



34

CROCIERA CARDANICA
крестовина - u-joint

Марка	Модель	Характеристики	Номер в каталоге автопроизводителя		Артикул Trialli
MAN	F 7/8 M/F 90 F 2000 TGM TGA/TGS/TGX	D 57 mm H 152 mm	MAN:	81.39108.6048	CC 705
DAF	F 2800/2900/3200 F 3300/3600 N 2800 F 75/85/95 85 CF 95 XF CF 75/85 XF 95		DAF:	1235571	
RENAULT TRUCKS	D/C/K/T				
VOLVO	FH/FM/FMX/NH 9/10/11/12/13/16 F/FL 6 F/FE/FL/FM 7				





Марка	Модель	Характеристики	Номер в каталоге автопроизводителя	Артикул Trialli
KAMAZ	6520	D 57 mm	KAMAZ: 6520-2205025 45104-2205100-90 45104-2205101-90	CC 705 
	6460	H 152 mm		
	5460			
MERCEDES-BENZ	L-Series: BM 343/346/352 O 300-/O 400-Series / Setra S 200-/ 300-Series: BM 345/397 Atego/Econic: Atego 1/2 950/952/953/954, 970/976 Econic 1 957 Actros/Antos/Arocs/Axor: Actros 1 950/954; Actros 2/3 930/934; Axor 375/950/952/953, 954 SK/MK/NG-Series: BM 387/389, 391/393/395, 620/621/622/623, 624/625, 645/646/647/648, 649, 652/653/654/655, 656/657/658/659		MERCEDES-BENZ: 3874100031	

VOLVO BUS

B 9 R
B 12 B /M
B 13 R

**MAN BUS /
NEOPLAN**



RH
Lion's Coach/Regio/Star Cityliner
Skyliner, Starliner, Tourliner,
Trendliner





36

CROCIERA CARDANICA
крестовина - u-joint

Марка	Модель	Характеристики	Номер в каталоге автопроизводителя		Артикул Trialli
MAN	F 7/8 F 90 L 2000	D 57 mm H 144 mm	MAN:	81.39126.6017	CC 706 
VOLVO	F 10 1976-1983 F 12 1976-1983 N 10/12 GWB		VOLVO:	232540	
RENAULT TRUCKS	CBH/CLM G/R Major		KAMAZ:	6520-2205025-10	
DAF	F 2800/2900/3200 F 3300/3600 N 2800 F 95				
IVECO	PA/P TurboTech EuroTech EuroStar				
VOLVO BUS	B 10 M (BR)				
KAMAZ	6520 6460 5460				





Марка	Модель	Характеристики	Номер в каталоге автопроизводителя		Артикул Trialli
MAN	F 7/8 M/F 90	D 52 mm H 133 mm	MAN:	81.39126.6021	CC 707 
DAF	F 2800/2900/3200 F 3300/3600 N 2800 F 75/85/95		DAF:	264 354	
RENAULT TRUCKS	CBH/CLM G/R Major		RENAULT:	00 03 397 100	
MERCEDES-BENZ	O 300-/O 400-Series / Setra S 200-/ 300-Series: BM 357/364/382/397, 664 L-Series: BM 336/346/349		GOLDEN DRAGON:	99114310125	
MAN BUS / NEOPLAN	SL/SG/Sb/SD NL/NG EL/bL				
YUTONG	ZK6129				
GOLDEN DRAGON	XML6102				
HIGER	KLQ6109Q 6129Q KLQ6118 KLQ6108 6118				



**CROCIERA CARDANICA**
крестовина - u-joint

Марка	Модель	Характеристики	Номер в каталоге автопроизводителя	Артикул Trialli
SCANIA	L-/P-/G-/R-/S-Series P 400/500/520, P 604/644 P-/G-/R-/T-Series P 500/510/520 Scania 2-/3-Series P-PF 50, P 500/510, P 520/540, T-TA 71/81 4-Series P 500/510, P 520/540	D 57 mm H 164 mm	SCANIA: 1 797 425 1879540	CC 710 
SCANIA BUS	F-/K-/N-Series P 500/510			
SCANIA	L-/P-/G-/R-/S-Series P 604/614/644 P-/G-/R-/T-Series P 600/602 Scania 2-/3-Series P-PF 60, P 600/610 4-Series P 300/310, P 400/410, P 420/440, P 500/510, P 520/540, P 610	D 65 mm H 190 mm	SCANIA: 1879541	CC 711 



Марка	Модель	Характеристики	Номер в каталоге автопроизводителя		Артикул Trialli
DAF	F 2800/2900/3200 F 3300/3600 N 2800 F 65/75/85 65/75 CF CF 75	D 47.6 mm H 135.2 mm	DAF:	1 250 299	CC 722
RENAULT TRUCKS	Midlum Premium /TR/PR Kerax AE Magnum Magnum E-Tech		RENAULT:	50 01 836 379	
IVECO	Eurocargo EuroTech		IVECO:	93160516	
KAMAZ	6520		KAMAZ:	6520-2201025-10	
MAN	F 2000	D 48 mm H 135.4 mm	MAN:	81.39126.6033	CC 724
MAN BUS / NEOPLAN	SL NL Lion's City/Classic		IVECO:	42534500	
IVECO	P/PA/MK Eurocargo TurboTech EuroTech EuroStar EuroTrakker		KAMAZ:	45104-2201100-90	
KAMAZ	6520				



40

CROCIERA CARDANICA
 крестовина - u-joint

Марка	Модель	Характеристики	Номер в каталоге автопроизводителя	Артикул Trialli
VOLVO	F/FL 6, F/FE/FL/FM 7 FL 6, -- chassis B264999, K 45, FL 7, NK 431 THK 91, NK 435 THK 91, NK 451 THK 91, NK 455 THK 91 FH/FM/FMX/NH 9/10/11/12/13/16 K 45 F/FL/N/NL 10/12/16 F 10/12/16, FL 10/12, N 10/12 NK 441/444, NK 451/455, NK-K45, NK-K46	D 50 mm H 152.6 mm	VOLVO: 1651032	CC 730
VOLVO BUS	B 10 B /BLE B 10 M B 12			
VOLVO	FH 12 1993-1998 FM 10 FM 12 1998-2001 NH 12 /BR	D 55 mm H 164.4 mm	VOLVO: 8127230	CC 751
RENAULT TRUCKS	Premium /TR/PR Kerax AE AE Magnum		RENAULT: 5001836375	



GMB	Trialli	Страница
210-0260	CC 490	16
G5-155X	CC 772	28
GU-1670	CC 470	16
GU-2050	CC 723	24
GU-7050	CC 508	17
GUIS-62	CC 760	26
GUK-12	CC 524	19
GUK-13	CC 441	15
GUK-14	CC 440	15
GUM-73	CC 549	21
GUM-75	CC 770	27

GMB	Trialli	Страница
GUM-80	CC 771	27
GUM-81	CC 401	11
GUM-91	CC 403	12
GUM-93	CC 402	11
GUM-99	CC 404	12
GUMZ-9	CC 526	19
GUN-29	CC 421	14
GUN-30	CC 515	18
GUN-35	CC 426	14
GUN-45	CC 410	13
GUN-46	CC 420	13

GMB	Trialli	Страница
GUN-50	CC 395	9
GUT-20	CC 552	23
GUT-23	CC 551	22
GUT-24	CC 550	22
GUT-29	CC 553	23
ST1539	CC 912	4
ST-1540	CC 901	3
ST1639	CC 905	3
ST1640	CC 910	4
ST1948	CC 914	7



42

CROCIERA CARDANICA
крестовина - u-joint

FEBI	Trialli	Страница
09921	CC 710	38
11546	CC 705	34, 35
11547	CC 706	36
11548	CC 702	33
11686	CC 730	40
14510	CC 707	37
14512	CC 441	15
23836	CC 722	39
38034	CC 751	40
38414	CC 748	25

FEBI	Trialli	Страница
38416	CC 747	24
38417	CC 749	25
47427	CC 761	26
47440	CC 770	27

Diesel Technic	Trialli	Страница
1.15020	CC 710	38
1.15200	CC 711	38
2.34001	CC 730	40
2.34003	CC 706	36
3.59004	CC 702	33
4.60111	CC 707	37
4.60390	CC 705	34, 35
5.14008	CC 722	39
6.59002	CC 751	40
7.20011	CC 724	39

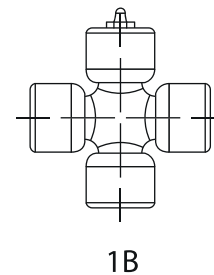
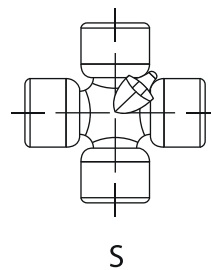
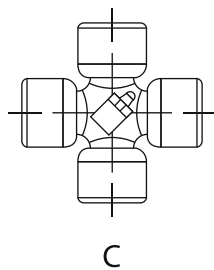
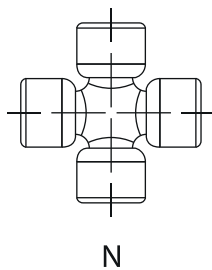
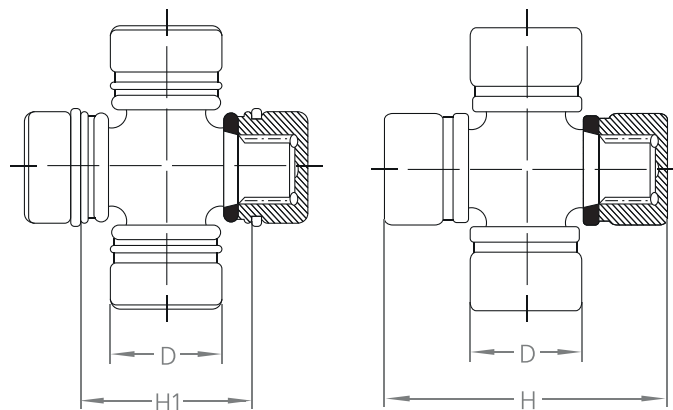



Артикул	D, мм	H ₁ , мм	H, мм	Тавотница	Страница
CC 901	15		40	N	3
CC 912	15,07		39	N	4
CC 905	16		39	N	3
CC 910	16		40	N	4
CC 902	19		44,6	S	5
CC 908	19		56,3	N	6
CC 538	19,05		55,5	N	20
CC 914	19,08		48	C	7
CC 410	20,06		52,8	N	13
CC 550	22,06		57,5	N	22
CC 146	23,84		61,24	1B	8
CC 506	23,84		61,24	1B	7
CC 441	24,06		74,4	N	15
CC 470	24,06		62	N	16
CC 529	24,06		64	N	20
CC 747	24,09		88,1	N	24
CC 401	25		63,8	1B	11
CC 403	25		76,8	S	12
CC 526	26,5	48	71	1B	19
CC 395	27		74,61	S	9



Артикул	D, мм	H ₁ , мм	H, мм	Тавотница	Страница
CC 420	27	46	72	1B	13
CC 490	27	52,6	81,75	S	16
CC 524	27		80	S	19
CC 549	27		82	S	21
CC 553	27		92,1	N	23
CC 749	27,08		88	N	25
CC 394	28		71	1B	8
CC 421	28	53,1	79,5	S	14
CC 440	28	48,2	77,2	C	15
CC 512	28	52,2	83	1B	9
CC 906	28	37	67,8	N	5
CC 907	28	42,5	73	N	6
CC 491	28,57	61,9	92,5	S	17
CC 508	29		77	S	17
CC 551	29,01	47,3	77,2	C	22
CC 562	29,98		92,1	N	10
CC 402	30	55	84,8	C	11
CC 404	30	71	101	C	12
CC 516	30		81,7	C	18
CC 561	30	55	88	1B	10



46

CROCIERA CARDANICA
крестовина - u-joint

Артикул	D, мм	H ₁ , мм	H, мм	Тавотница	Страница
CC 515	30,18		92	N	18
CC 723	30,24		106,3	S	24
CC 748	31,08		88,5	1B	25
CC 770	31,75		102	S	27
CC 426	32	65,1	99,9	C	14
CC 542	32	57	92	S	21
CC 552	32,01	60	92	S	23
CC 761	33		93	C	26
CC 772	34,92	72	106,5	S	28
CC 655	34,95		106,3	N	29
CC 653	35		98	C	28
CC 760	35		103,9	S	26
CC 620	39		118	S	32
CC 621	39		118	C	33
CC 771	46		142	C	27
CC 722	47,6		135,2	C	28
CC 724	48		135,4	C	39
CC 613	50		155	C	30
CC 614	50		135	C	30
CC 617	50		155	C	31



Артикул	D, мм	H ₁ , мм	H, мм	Тавотница	Страница
CC 730	50		152,6	C	40
CC 619	52		154	C	31
CC 702	52		147,2	C	33
CC 707	52		133	C	37
CC 751	55		164,4	C	40
CC 705	57		152	C	34, 35
CC 706	57		144	C	36
CC 710	57		164	C	38
CC 612	62		173	C	29
CC 711	65		190	C	38

WWW.TRIALLI.RU



Большой запас по мощности передаваемого момента

Мы рачитали все возможные пиковые нагрузки и...
И добавили еще прочности. Только так получается
действительно надежная деталь.



Продуманная комплектация –

Наличие уплотнителей и крепежных деталей позволяет
гарантировать высокую надежность и длительную работу
отремонтированных узлов.



4 - Прецизионный класс точности



Высокая статическая и динамическая грузоподъемность -

Подшипники TRIALLI обладают высокой статической
и динамической грузоподъемностью.